

FUSE CLIPS

- PC thru mount, surface mount and rivet types for 5mm, 1AG, 2AG, 3AG, 4AG, 5AG, 7AG & 8AG fuse sizes
- Low contact resistance
- Withstands shock and vibration
- Rated 6.3 to 30 Amps
- Custom designs and modifications available to your specifications

PC THRU MOUNT TYPES

- Available for 5mm, 1AG, 2AG, 3AG, 5AG, 7AG & 8AG sizes
- Low profile, space saving
- Snap-fit design enhances assembly and PC retention for wave soldering
- Available with orientation legs to assure proper PC installation
- Available with or without end stops

SURFACE MOUNT & RIVET TYPES

- Available for 5mm, 1AG, 2AG, 3AG, 4AG, 7AG & 8AG sizes
- Available with straight or 45° solder lugs
- Available with .187 (4.7), .205 (5.2) or .250 (6.4) or quick-fit tabs
- Low profile, space saving
- Available with or without end stops

Refer to pages 38-40 for Fuse Clip Layout and Mounting Details

5mm PC Clips



3517 3518P

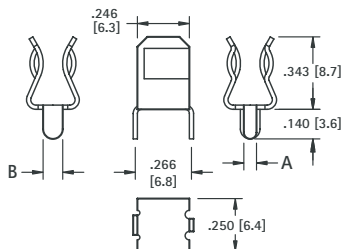

With or Without Orientation Legs

MATERIAL:

.020 (.51) thick Brass, Tin Plate

Current Rating: 15 Amps

CAT. NO.	A	B
3517	.060 (1.5)	.060 (1.5)
3518P	.060 (1.5)	.093 (2.4)



3512 3512P

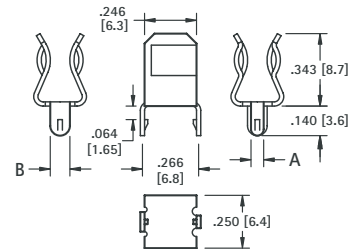

With or Without Orientation Legs

- With snap-in PC legs

MATERIAL:

.020 (.51) thick Brass, Tin Plate

Current Rating: 15 Amps

CAT. NO.	A	B
3512	.060 (1.5)	.060 (1.5)
3512P	.060 (1.5)	.093 (2.4)

FUSE CLIPS



MATERIAL:

.016 (.41) thick Brass, Tin Plate

Current Rating: 6.3 Amps

CAT. NO. 3520

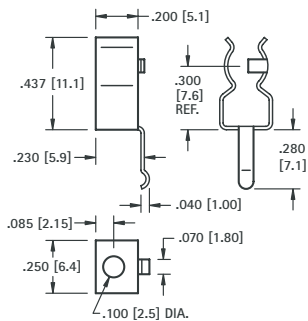

MATERIAL:

.016 (.41) thick Brass, Tin Plate

Current Rating: 10 Amps

CAT. NO. 3519

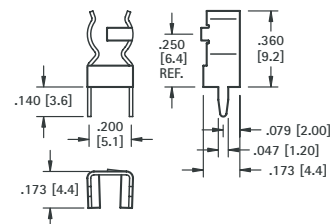

Mounting Detail

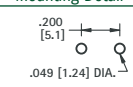

For 2AG or 5mm



3521 3561

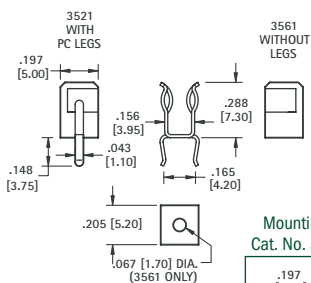

Mounting Detail Cat. No. 3521 Only

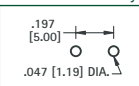

MATERIAL:

.016 (.41) thick Brass, Tin Plate

Current Rating: 10 Amps

CAT. NO. 3521 (THM with PC Legs)

CAT. NO. 3561 (SMT with Hole)

For 5mm/3AG



MATERIAL:

.016 (.41) thick Brass, Tin Plate

Current Rating: 15 Amps

CAT. NO. 3562

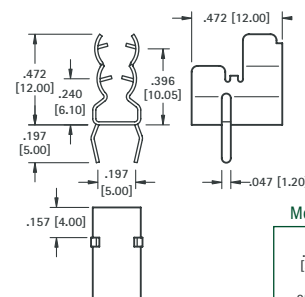

Mounting Detail

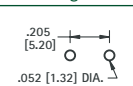

For 4AG (9/32 Dia.)



MATERIAL:

.020 (.51) thick Brass, Nickel Plate

Current Rating: 15 Amps

CAT. NO. 3565 (Without End Stops)

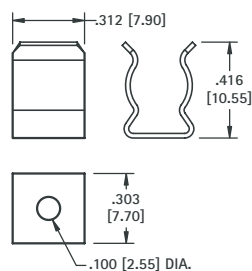

For 5AG (13/32 Dia.)



MATERIAL:

.030 (.76) thick Brass, Tin Plate

Current Rating: 30 Amps

CAT. NO. 3566

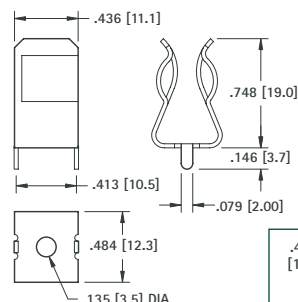

Mounting Detail

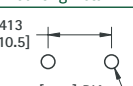

5mm FUSE HOLDERS

SLIM LINE & OPTIONAL COVER

• For 5mm x 20mm Fuse

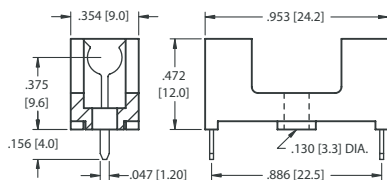

Mounting Detail

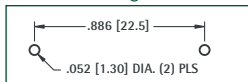

SPECIFICATIONS

Base & Cover: Nylon,
UL Rated 94V-0
Clips: Brass, Tin Plate
Rated: 5 Amps @ 250V AC

CAT. NO. 4628 - Holder

CAT. NO. 4628C - Cover only (with window)

- Optional cover with window protects and insulates fuse
- Flame Retardant

LOW PROFILE & OPTIONAL COVER

• For 5mm x 20mm Fuse

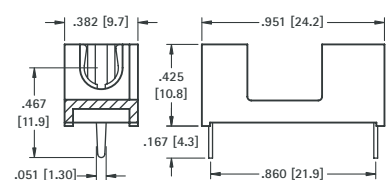

Mounting Detail

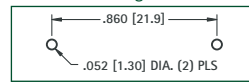

SPECIFICATIONS

Base & Cover: Nylon,
UL Rated 94V-0
Clips: Brass, Tin Plate
Rated: 5 Amps @ 250V AC

CAT. NO. 4527 - Holder

CAT. NO. 4527C - Cover only

- Low profile, space saving design
- Optional cover protects and insulates fuse
- Flame Retardant

FULLY INSULATED

• For 5mm x 20mm Fuse

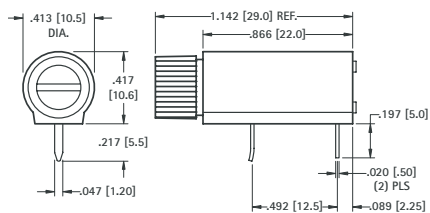

Mounting Detail

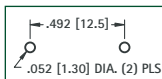

SPECIFICATIONS

Base: PBT
Contacts: Brass, Tin Plate
Rated: 10 Amps @ 250V AC

CAT. NO. 4525

- Shock resistant
- Ideal for board edge designs
- Fuse can be accessed from board edge
- Fuse is completely enclosed, protecting fuse from shorting and breaking
- End cap and body supplied unassembled

PC SNAP-IN FUSE HOLDER

• For 5mm x 20mm Fuse

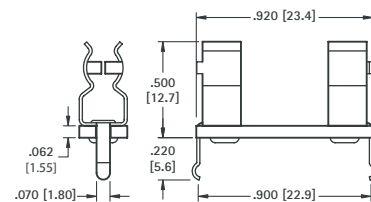

Mounting Detail

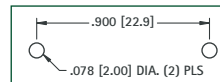

SPECIFICATIONS

Base: .062 (1.57) G-10, UL Rated 94V-0
Clips: Brass, Tin Plate
Rated: 6.3 Amps @ 250V AC

CAT. NO. 3527 - Holder

- Snap-in design for wave soldering
- Flame Retardant
- Optional cover protects and insulates fuse - **Cat. No. 3527C**

5mm & 3AG FUSE HOLDERS

3AG FUSE HOLDERS

- For 3AG Fuses .250 x 1.250 (6.35 x 31.8)
- Provides greater mechanical strength than individual clips
- Flame Retardant
- One piece construction assures proper fuse clip orientation which also increases production efficiency
- **Rated:** 15 Amps @ 500V AC

TERMINATION LUGS CAN BE USED WITH WIRES OR PC MOUNT

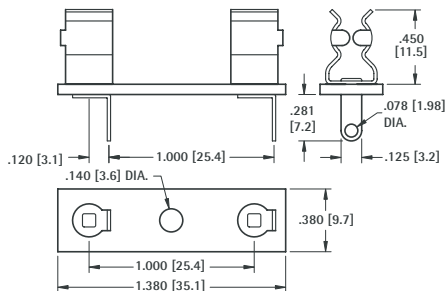

Mounting Detail

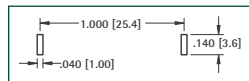

SPECIFICATIONS
Base: .062 (1.57) GPO-3,
UL Rated 94V-0
Clips: Brass, Tin Plate

CAT. NO. 3526

Optional cover available - **Cat. No. 4245C**

PRESS-FIT, IDEAL FOR WAVE SOLDERING

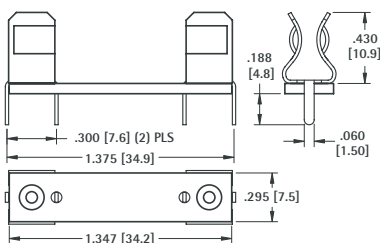

Mounting Detail

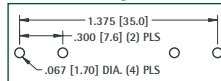

SPECIFICATIONS
Base: .062 (1.57) GPO-3,
UL Rated 94V-0
Clips: Brass, Tin Plate

CAT. NO. 4245

Optional cover available - **Cat. No. 4245C**

SNAP-IN DESIGN ASSURES STABILITY DURING WAVE SOLDERING

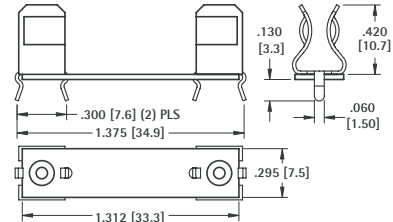

Mounting Detail

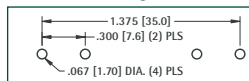

SPECIFICATIONS
Base: .032 (1.57) G-10,
UL Rated 94V-0
Clips: Brass, Tin Plate

CAT. NO. 4250

Optional cover available - **Cat. No. 4245C**

.250 (6.4) DIAMETER FUSE CLIPS

Refer to pages 38-40 for Fuse Clip Layout and Mounting Details

For 1AG, 3AG, 7AG, 8AG THRU HOLE MOUNT TYPES

WITH SNAP-IN PC LEGS



MATERIAL:
.020 (.51) thick Brass, Tin Plate
Current Rating: 15 Amps

CAT. NO. 3513

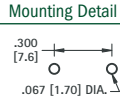
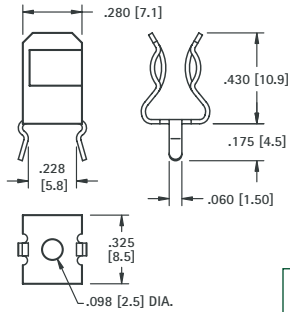

WITH SNAP-IN PC LEGS

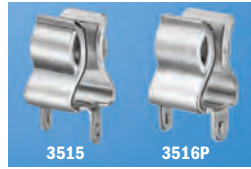

MATERIAL:
.020 (.51) thick Brass, Tin Plate
Current Rating: 15 Amps

CAT. NO.	A	B
3515	.060 (1.5)	.060 (1.5)
3515P	.060 (1.5)	.093 (2.4)
3516P	.060 (1.5)	.120 (3.0)

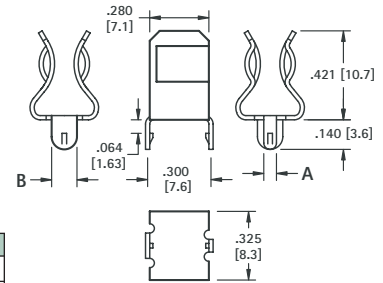

With or Without Orientation Legs

WITH STRAIGHT PC LEGS



MATERIAL:
.020 (.51) thick Brass, Tin Plate
Current Rating: 15 Amps

CAT. NO. 3530

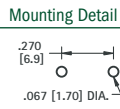
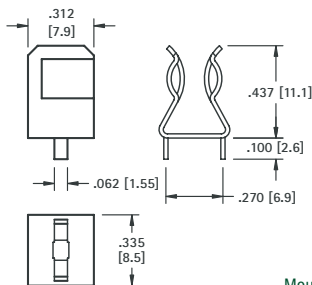

WITH STRAIGHT PC LEGS



MATERIAL:
.020 (.51) thick Brass, Tin Plate
Current Rating: 15 Amps

CAT. NO.	H	L	END STOPS
3510	.421 (10.7)	.140 (3.6)	NO
3529	.421 (10.7)	.140 (3.6)	YES
3511	.430 (10.9)	.250 (6.4)	NO
3514	.430 (10.9)	.250 (6.4)	YES

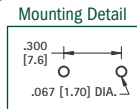
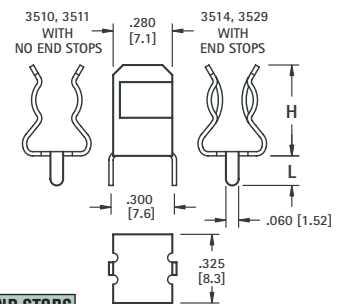

WITH SOLDER LUG



MATERIAL:
.020 (.51) thick Brass, Nickel Plate
Current Rating: 15 Amps

CAT. NO.	A	B
3533	Flat	.656 (16.7)
3535	45°	.562 (14.3)
3570	-	NO TAB

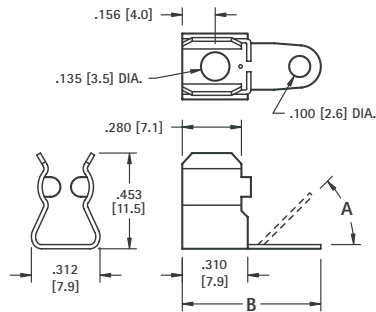

For 1AG, 3AG, 7AG, 8AG RIVET & SURFACE MOUNT TYPES

LOW PROFILE



MATERIAL:
.020 (.51) thick Brass, Nickel Plate
Current Rating: 15 Amps

CAT. NO. 3531 (Without End Stops)

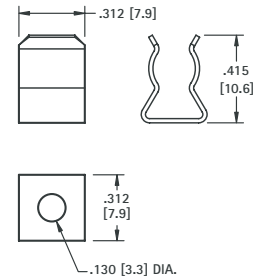

WITH QUICK-FIT TAB



MATERIAL:
.020 (.51) thick Brass, Nickel Plate
Current Rating: 15 Amps

CAT. NO.	A	B
4246	.020 (0.5)	.187 (4.7)
4247	.020 (0.5)	.205 (5.2)
4244	.032 (0.8)	.250 (6.4)

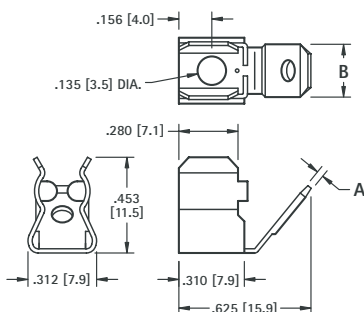

WITH OR WITHOUT END STOPS



MATERIAL:
.020 (.51) thick Brass, Nickel Plate
Current Rating: 15 Amps

CAT. NO.	END STOPS
3532	YES
3567	NO

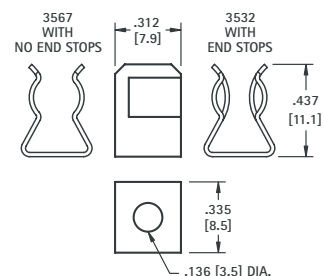

3AG RIVET TYPE FUSE HOLDERS

- Available in Flame Retardant fiberglass base or Phenolic base
- Fuse clips riveted to .125 (3.2) thick base for rugged applications

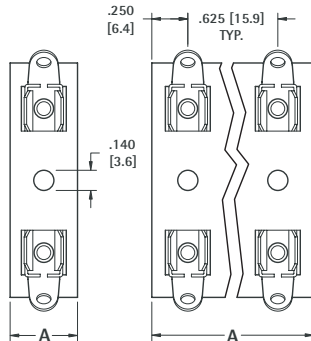
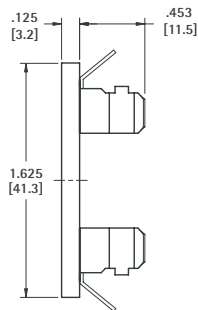

FIG. 1

FIG. 2

SPECIFICATIONS

Black Phenolic Base: .125 (3.2) thick NEMA Grade XP & FED L-P-509. Max. operating temperature 266°F (130°C) continuous. UL Rated 94-HB

Fiberglass Base: .125 (3.2) thick NEMA Grade GPO 3. Max. operating temperature 300°F (148°C) continuous. UL Rated 94V-0, Flame Retardant

Clips: Brass, Nickel Plate (Cat. No. 3535)

Rated: 15 Amps @ 500V AC

BLACK PHENOLIC CAT. NO.	FIBER-GLASS CAT. NO.	HOLDS NO. OF FUSES	FIG. NO.	A
3536	3540	1	1	.500 (12.7)
3537	3541	2	2	1.125 (28.6)
3538	3542	3	2	1.750 (44.5)
3539	3543	4	2	2.375 (60.3)

MOLDED 3AG FUSE HOLDERS

- Quick-Fit Tab, .250 (6.4) × .032 (.81) size, accepts standard .250 (6.4) quick-fit female terminals. Eliminates the need for soldering
- Available with solder lugs or .250 (6.4) Quick-Fit Tabs
- Molded with barriers to prevent and withstand test of 1080 VRMS at 60Hz for 1 minute at 3000V DC
- Flame Retardant

SPECIFICATIONS

Molded Base: LCP, UL Rated 94V-0.

Clips: Brass, Nickel Plate

Rated: 15 Amps @ 500V AC



SOLDER LUG

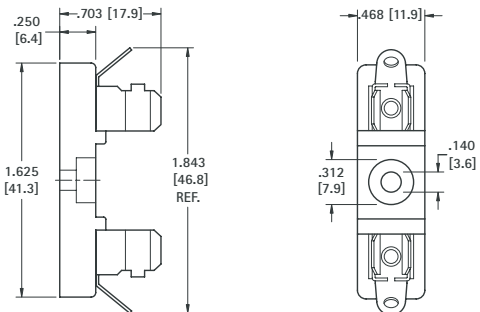

Assembled with Clip, Cat. No. 3535

CAT. NO. 3523

QUICK-FIT

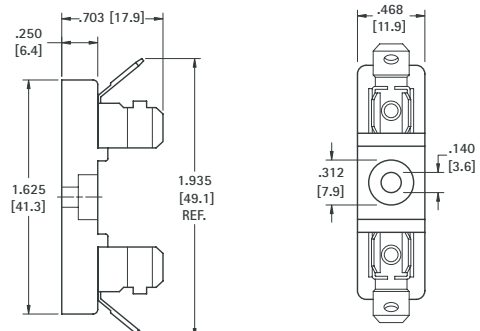

Assembled with Clip, Cat. No. 4244

CAT. NO. 4243

3AG FUSE HOLDERS

5mm & 3AG FUSE COVERS

5mm

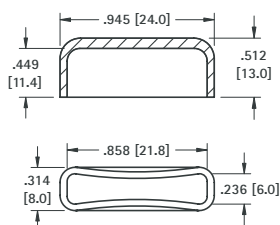

CAT. NO. 3527C

MATERIAL: PVC, UL Rated 94V-0

3AG

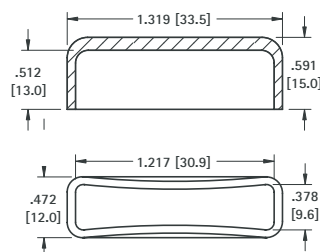

CAT. NO. 4245C

MATERIAL: PVC, UL Rated 94V-0

- Made from flame retardant PVC that will protect fuse from shorting and from minor bumps
 - Fits any 5mm × 20mm or 3AG fuse
 - Cover fits over fuse and fuse clip
- Can be used with fuse holders or fuse clips